



Auranet

User Guide

300Mbps Wireless N Outdoor Access Point

CAP300-Outdoor

REV1.0.0
1910012023

COPYRIGHT & TRADEMARKS

Specifications are subject to change without notice.  **tp-link** is a registered trademark of TP-Link Technologies Co., Ltd. Other brands and product names are trademarks or registered trademarks of their respective holders.

No part of the specifications may be reproduced in any form or by any means or used to make any derivative such as translation, transformation, or adaptation without permission from TP-Link Technologies Co., Ltd. Copyright © 2017 TP-Link Technologies Co., Ltd.. All rights reserved.

FCC STATEMENT



This equipment has been tested and found to comply with the limits for a Class B digital device, pursuant to part 15 of the FCC Rules. These limits are designed to provide reasonable protection against harmful interference in a residential installation. This equipment generates, uses and can radiate radio frequency energy and, if not installed and used in accordance with the instructions, may cause harmful interference to radio communications. However, there is no guarantee that interference will not occur in a particular installation. If this equipment does cause harmful interference to radio or television reception, which can be determined by turning the equipment off and on, the user is encouraged to try to correct the interference by one or more of the following measures:

- Reorient or relocate the receiving antenna.
- Increase the separation between the equipment and receiver.
- Connect the equipment into an outlet on a circuit different from that to which the receiver is connected.
- Consult the dealer or an experienced radio/ TV technician for help.

This device complies with part 15 of the FCC Rules. Operation is subject to the following two conditions:

- 1) This device may not cause harmful interference.
- 2) This device must accept any interference received, including interference that may cause undesired operation.

Any changes or modifications not expressly approved by the party responsible for compliance could void the user's authority to operate the equipment.

Note: The manufacturer is not responsible for any radio or TV interference caused by unauthorized modifications to this equipment. Such modifications could void the user's authority to operate the equipment.

FCC RF Radiation Exposure Statement:

This equipment complies with FCC RF radiation exposure limits set forth for an uncontrolled environment. This device and its antenna must not be co-located or operating in conjunction with any other antenna or transmitter.

"To comply with FCC RF exposure compliance requirements, this grant is applicable to only Mobile Configurations. The antennas used for this transmitter must be installed to provide a separation distance of at least 20 cm from all persons and must not be co-located or operating in conjunction with any other antenna or transmitter."

CE Mark Warning

CE 1588

This is a class B product. In a domestic environment, this product may cause radio interference, in which case the user may be required to take adequate measures.

RF Exposure Information

This device meets the EU requirements (1999/5/EC Article 3.1a) on the limitation of exposure of the general public to electromagnetic fields by way of health protection.

The device complies with RF specifications when the device is used at 20 cm from your body.

Canadian Compliance Statement

This device complies with Innovation, Science and Economic Development Canada license-exempt RSSs. Operation is subject to the following two conditions:

- 1) This device may not cause interference, and
- 2) This device must accept any interference, including interference that may cause undesired operation of the device.

Le présent appareil est conforme aux CNR d'Industrie Canada applicables aux appareils radio exempts de licence. L'exploitation est autorisée aux deux conditions suivantes :

- 1) l'appareil ne doit pas produire de brouillage;
- 2) l'utilisateur de l'appareil doit accepter tout brouillage radioélectrique subi, même si le brouillage est susceptible d'en compromettre le fonctionnement.

Radiation Exposure Statement

This equipment complies with ISED radiation exposure limits set forth for an uncontrolled environment. This equipment should be installed and operated with minimum distance 20cm between the radiator & your body.

Déclaration d'exposition aux radiations

Cet équipement est conforme aux limites d'exposition aux rayonnements ISED établies pour un environnement non contrôlé. Cet équipement doit être installé et utilisé avec un minimum de 20 cm de distance entre la source de rayonnement et votre corps.

Innovation, Science and Economic Development Canada

Statement

CAN ICES-3 (B)/NMB-3(B)

Korea Warning Statements

당해 무선설비는 운용중 전파혼신 가능성이 있음.



Продукт сертифіковано згідно с правилами системи УкрСЕПРО на відповідність вимогам нормативних документів та вимогам, що передбачені чинними законодавчими актами України.



Safety Information

- When product has power button, the power button is one of the way to shut off the product; When there is no power button, the only way to completely shut off power is to disconnect the product or the power adapter from the power source.
- Don't disassemble the product, or make repairs yourself. You run the risk of electric shock and voiding the limited warranty. If you need service, please contact us.
- Avoid water and wet locations.
- Adapter shall be installed near the equipment and shall be easily accessible.
- The plug considered as disconnect device of adapter.



Use only power supplies which are provided by manufacturer and in the original packing of this product. If you have any questions, please don't hesitate to contact us.

NCC Notice & BSMI Notice

注意！

依據 低功率電波輻射性電機管理辦法



第十二條 經型式認證合格之低功率射頻電機，非經許可，公司、商號或使用者均不得擅自變更頻率、加大功率或變更原設計之特性或功能。

第十四條 低功率射頻電機之使用不得影響飛航安全及干擾合法通行；經發現有干擾現象時，應立即停用，並改善至無干擾時方得繼續使用。前項合法通信，指依電信規定作業之無線電信。低功率射頻電機需忍受合法通信或工業、科學以及醫療用電波輻射性電機設備之干擾。

安全諮詢及注意事項

- 請使用原裝電源供應器或只能按照本產品注明的電源類型使用本產品。
- 清潔本產品之前請先拔掉電源線。請勿使用液體、噴霧清潔劑或濕布進行清潔。
- 注意防潮，請勿將水或其他液體潑灑到本產品上。
- 插槽與開口供通風使用，以確保本產品的操作可靠並防止過熱，請勿堵塞或覆蓋開口。
- 請勿將本產品置放於靠近熱源的地方。除非有正常的通風，否則不可放在密閉位置中。
- 請不要私自打開機殼，不要嘗試自行維修本產品，請由授權的專業人士進行此項工作。

Explanation of the symbols on the product label

Symbol	Explanation
	DC voltage
	<p>RECYCLING</p> <p>This product bears the selective sorting symbol for Waste electrical and electronic equipment (WEEE). This means that this product must be handled pursuant to European directive 2012/19/EU in order to be recycled or dismantled to minimize its impact on the environment.</p> <p>User has the choice to give his product to a competent recycling organization or to the retailer when he buys a new electrical or electronic equipment.</p>

CONTENTS

About this User Guide	1
Chapter 1 Introduction	2
Chapter 2 Working Mode.....	3
2.1 FIT Mode.....	3
2.2 FAT Mode.....	5
Chapter 3 Status.....	8
3.1 Device Information	8
3.2 Wireless Parameter	8
3.3 Wireless Service.....	9
3.4 Wireless Client	10
Chapter 4 Wireless.....	11
4.1 Wireless.....	11
4.2 WDS Settings	14
4.3 Advanced Settings	16
Chapter 5 Network.....	19
5.1 Wireless MAC Filtering	19
5.2 VLAN Settings	20
Chapter 6 System.....	21
6.1 AP Management	22
6.2 Account	23
6.3 System Log	23
6.4 Time Setting.....	24
6.5 Configuration Management.....	25
6.6 Firmware Upgrade	25
6.7 Ping Watch Dog.....	26

About this User Guide

When using this guide, please notice that features of the CAP may vary slightly depending on the model and software version you have, and on your location, language, and Internet service provider. All screenshots, images, parameters and descriptions documented in this guide are used for demonstration only.

The information in this document is subject to change without notice. Every effort has been made in the preparation of this document to ensure accuracy of the contents, but all statements, information, and recommendations in this document do not constitute the warranty of any kind, express or implied. Users must take full responsibility for their application of any product.

Convention

- Some models featured in this guide may be unavailable in your country or region. For local sales information, visit <http://www.tp-link.com>.
- Unless otherwise noted, the CAP or the device mentioned in this guide stands for CAP300 -Outdoor.

More Info

The latest software can be found at Download Center at www.tp-link.com/support.

The Quick Installation Guide can be found where you find this guide or inside the package of the CAP.

Specifications can be found on the product page at <http://www.tp-link.com>.

A Technical Support Forum is provided for you to discuss our products at <http://forum.tp-link.com>.

Our Technical Support contact information can be found at the Contact Technical Support page at www.tp-link.com/support.

Chapter 1 Introduction

Auranet series products provide wireless coverage solutions for small-medium business. They can either work independently in FAT mode or be centrally managed by the wireless controller in FIT mode, providing a flexible, richly-functional but easily-configured enterprise-grade wireless network for small and medium business.

CAP300-Outdoor:

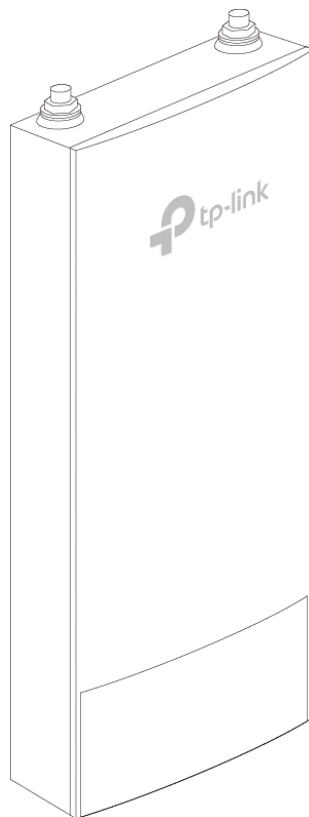

Figure 1-1 Top View of the CAP

Chapter 2 Working Mode

CAPs support two working modes including FIT mode and FAT mode. In FIT mode, APs can be centrally managed by TP-Link's wireless controller. The default FIT mode is used when you want to deploy a large wireless network. The management of every single AP in the network is complex and complicated. With the wireless controller, you can centrally manage the mass APs simply in a web browser.

In FAT mode, you can log in to AP's webpage to manage the AP alone. The FAT mode is used in a small wireless network. The AP cannot be managed by wireless controller in FAT mode.

2.1 FIT Mode

In the default FIT mode, CAP should be managed by the wireless controller. Please refer to the **Wireless Controller User Guide** from our website at www.tp-link.com to learn more information about configuring and using the CAPs by the controller.

Typical topology in FIT mode:

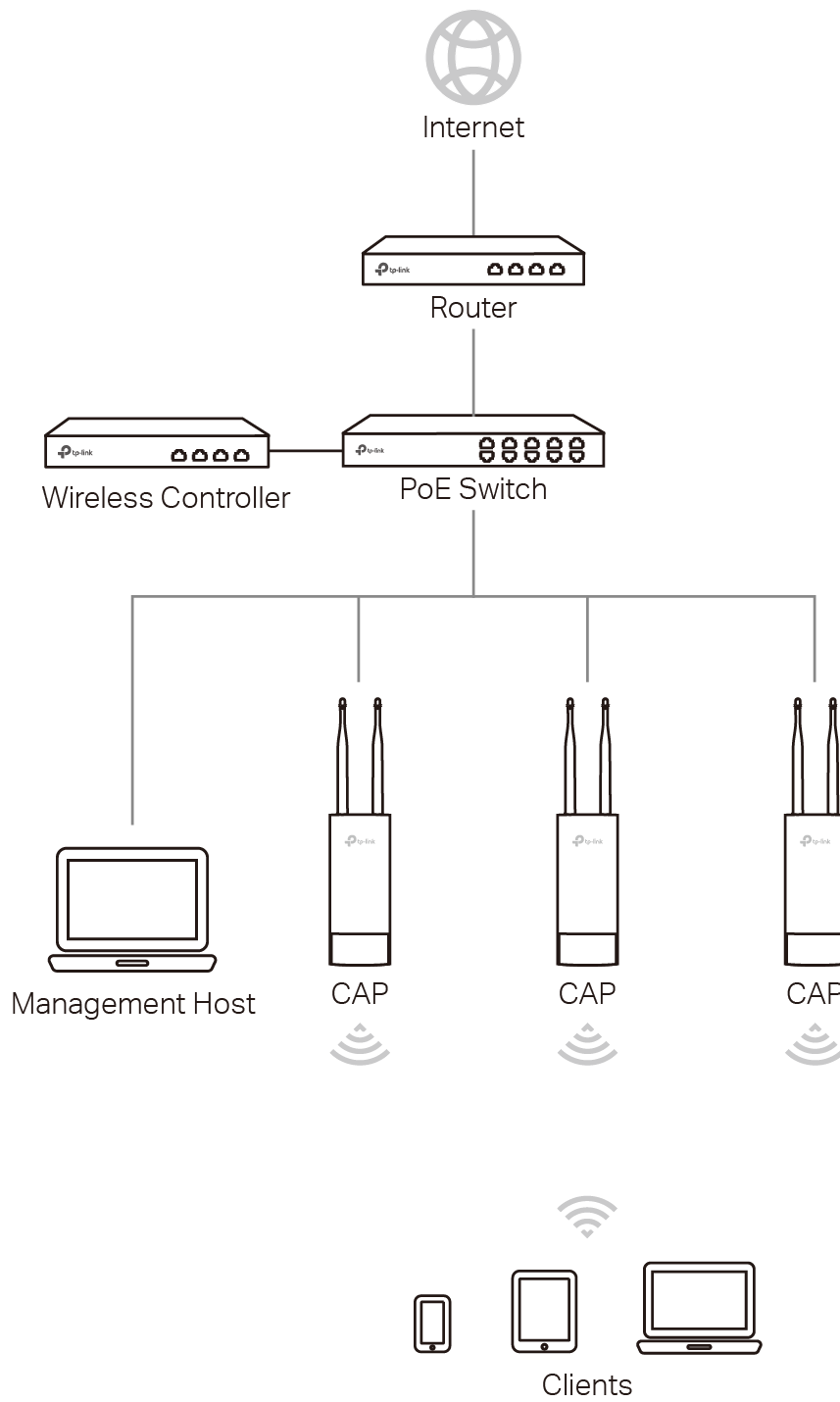

Figure 2-1 Typical Topology in FIT Mode

NOTE:

The IP address of the wireless controller must be reachable for the CAPs in the network.

2.2 FAT Mode

In FAT mode, you can log in to AP's webpage to manage the AP alone. The FAT mode is used in a small wireless network.

Typical topology in FAT mode:

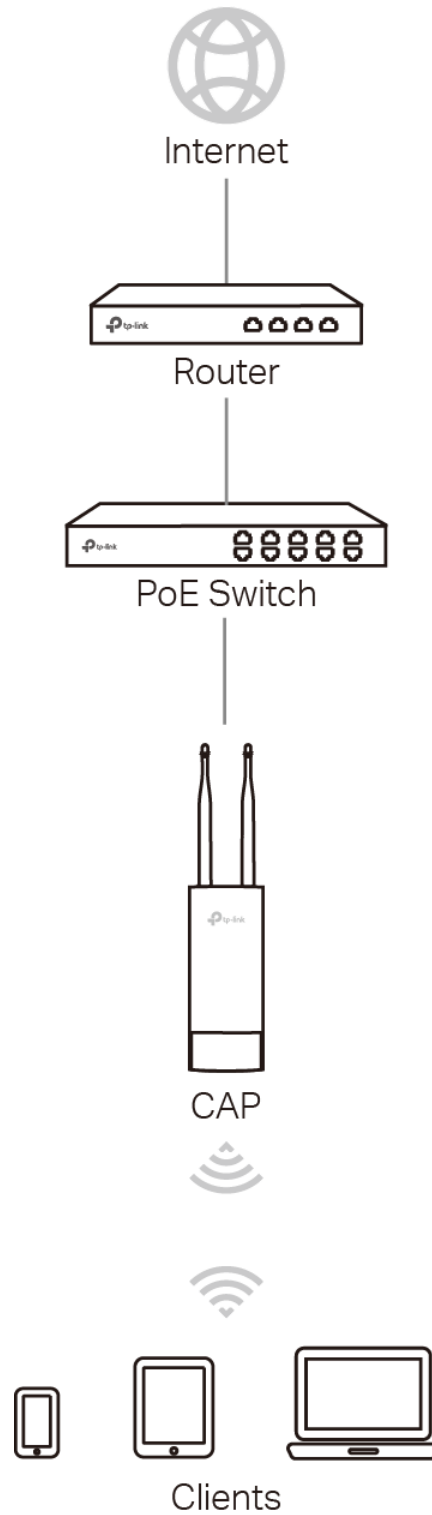
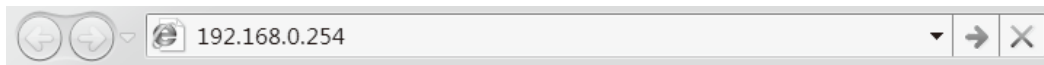

Figure 2-2 Typical Topology in FIT Mode

Follow the steps below to log in to the web interface.

1. Launch a web browser, enter 192.168.0.254 in the address field and press the **Enter** key.



NOTE:

To log in to the device, the IP address of your PC should be set in the same subnet addresses of the device. The IP address is 192.168.0.x ("x" is any number from 1 to 253). Subnet Mask is 255.255.255.0.

2. Create a new username and password for login, and then click **OK**.

A screenshot of the TP-Link login form. The form has a dark teal header with the TP-Link logo and the text "tp-link". Below the header, there are three input fields: "New Username:", "New Password:", and "Confirm the Password:". Below the input fields, there is a note: "Note: Please remember the administrator account and password for login. If you forget, you can reset the device to its factory defaults." At the bottom of the form, there is an "OK" button.

Figure 2-3 Login

3. The webpage will be shown as below. Click the menu bar to configure the corresponding parameters.

Status **Wireless** **Network** **System**

Device Information

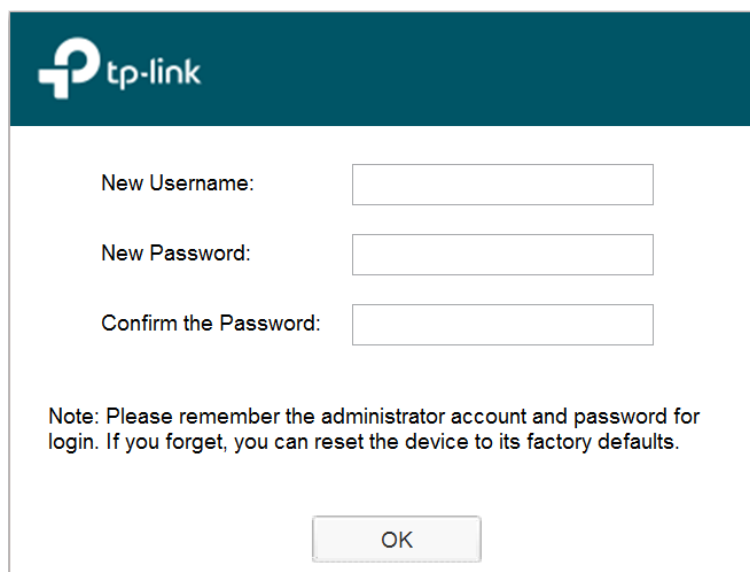
Hardware Version: CAP300-Outdoor v1.0
MAC Address: 00-14-78-87-43-96
IP Address: 192.168.0.31
System Time: 2014-01-01 00:46:38
Running Time: 0 days 00:46:39

Wireless Parameter

Wireless Mode: 802.11b/g/n
Channel Bandwidth: Auto
Channel Frequency: 13
WDS Status: Disabled

Wireless Service

ID	SSID	Network Type	Wireless Password	Client Number	Status	Settings
1	TP-LINK_2.4G_874396	Guest Network		0	Enable	

Wireless Client

ID	MAC Address	Connected SSID	Connection Time
Client list is empty.			

Figure 2-4 Status

TIPS:

Proceed to the following chapters for information on configuring the CAP in FAT mode.

Chapter 3 Status

The **Status** page displays the device information, wireless parameter, wireless service and wireless client of the CAP.

The screenshot shows the 'Status' page with three tabs: 'Wireless', 'Network', and 'System'. The 'Wireless' tab is selected. The page is divided into four sections:

- Device Information:** Hardware Version: CAP300-Outdoor v1.0, MAC Address: 00-14-78-87-43-96, IP Address: 192.168.0.31, System Time: 2014-01-01 00:46:38, Running Time: 0 days 00:46:39.
- Wireless Parameter:** Wireless Mode: 802.11b/g/n, Channel Bandwidth: Auto, Channel Frequency: 13, WDS Status: Disabled.
- Wireless Service:** A table with columns: ID, SSID, Network Type, Wireless Password, Client Number, Status, Settings. One entry is shown: ID 1, SSID TP-LINK_2.4G_874396, Network Type Guest Network, Client Number 0, Status Enable, and a settings icon.
- Wireless Client:** A table with columns: ID, MAC Address, Connected SSID, Connection Time. The text 'Client list is empty.' is displayed below the table. A 'Refresh' button is at the bottom right.

Figure 3-1 Status Page

3.1 Device Information

This section displays the information of hardware version, MAC address, IP address, system time and running time of the CAP. If you want to modify the IP address of the CAP, Please refer to **AP Management**. To modify the system time, please refer to **Time Setting**.

The screenshot shows the 'Device Information' section with the following details:

- Hardware Version: CAP300-Outdoor v1.0
- MAC Address: 00-14-78-87-43-96
- IP Address: 192.168.0.31
- System Time: 2014-01-01 00:46:38
- Running Time: 0 days 00:46:39

Figure 3-2 Device Information

3.2 Wireless Parameter

This section displays the wireless mode, channel bandwidth, channel frequency and WDS status of the device. Please refer to **Advanced Settings** to configure the wireless

mode, channel bandwidth and channel frequency and refer to **WDS Settings** to configure the WDS feature.

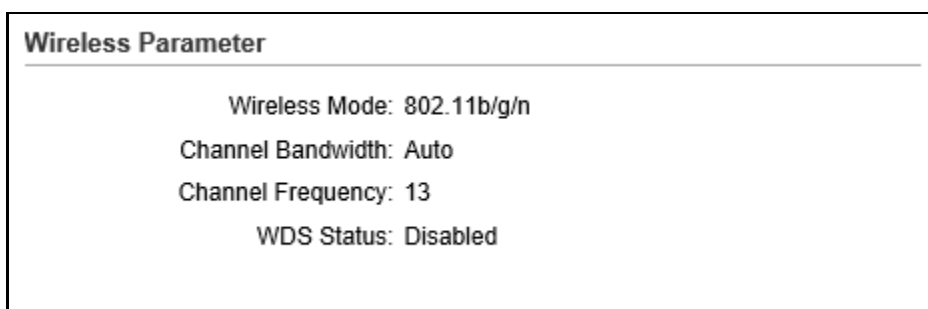

Figure 3-3 Wireless Parameter

3.3 Wireless Service

In this section, you can check or edit the wireless service information of the CAP.

Wireless Service

ID	SSID	Network Type	Wireless Password	Client Number	Status	Settings
1	TP-LINK_2.4G_874396	Guest Network		0	Enable	

Figure 3-4 Wireless Service

Click the button to edit the corresponding wireless service entry. You can change the SSID, Network type and password. Check or uncheck the status box to enable or disable the wireless service as needed.

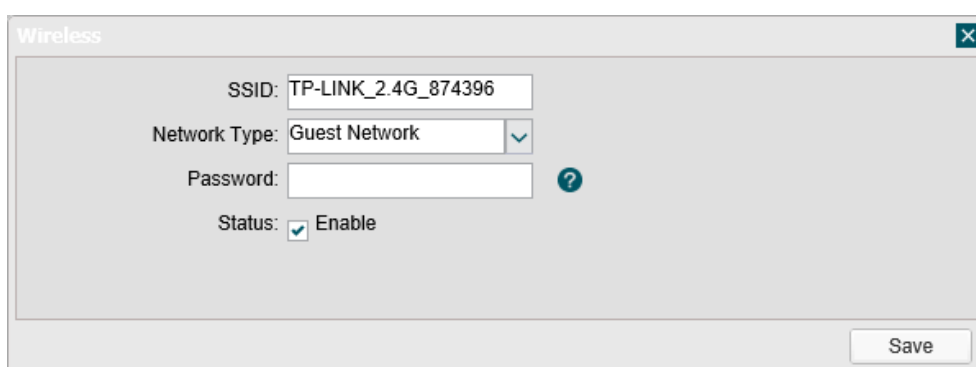

Figure 3-5 Wireless

NOTE:

If the wireless network is not encrypted, changing password here will encrypt the network with WPA-PSK/WPA2-PSK. If the wireless network has been already encrypted, changing password here will not change the encryption type.

3.4 Wireless Client

The wireless client table displays the information of the connected clients including their MAC address, connected SSID and the connection time.

ID	MAC Address	Connected SSID	Connection Time
Client list is empty.			

Figure 3-6 Wireless Client

Chapter 4 Wireless

Wireless page consists of Wireless, WDS Settings and Advanced Settings.

The screenshot shows the 'Wireless' configuration page with the following sections:

- Wireless:** A table with columns: ID, SSID, Code Type, Network Type, Security Mode, Password, AP Isolation, Status, Settings. One entry is visible: ID 1, SSID TP-LINK_2.4G_87..., Code Type ---, Network Type Guest Network, Security Mode None, Password, AP Isolation Enable, Status Enable, Settings (gear icon).
- WDS Settings:** WDS: Enable, Scan button, SSID: TP-LINK, BSSID: 00-00-00-00-00-01, Security Mode: None. OK button.
- Advanced Settings:** Wireless Mode: 802.11b/g/n, Channel Bandwidth: Auto, Channel: Auto, Transmit Power(EIRP): 20 dBm, SSID Isolation: Enable, Beacon Interval: 100 ms (40-1000), Maximum Users: 100 (1-100). Two options for signal strength filtering are present, both with Enable and a value of -75 dBm.

Figure 4-1 Wireless Page

If you have made any change of the parameters, please click **OK** to make the configuration take effect. There will be a blue bar at the top of the page to remind you to save the configuration. Click **Save** when you finish all settings, otherwise all the settings will be recovered to last saved settings at reboot or power off.

Your unsaved configurations will be lost when the device reboots. Save now?

Save

NOTE:

Proceed to the following chapter for information on configuring the wireless network of the CAP.

4.1 Wireless

This section allows you to configure the wireless basic settings, such as SSID, network type, security mode, and password of each wireless service entry.

ID	SSID	Code Type	Network Type	Security Mode	Password	AP Isolation	Status	Settings
1	TP-LINK_2.4G_87...	---	Guest Network	None		Enable	Enable	

Figure 4-2 Wireless

Click **Add** to create a new wireless service. Click button to edit the corresponding wireless service.

Wireless ✕

Add Delete

SSID: Enable Broadcast ?

Network Type: ?

Security Mode: ?

AP Isolation: Enable ?

Enable Wireless Network: Enable

SSID: Enter a character string no more than 32 characters to name your wireless network. We suggest you to set an easy-to-remember SSID to conveniently identify your wireless network.

Check the box of **Enable Broadcast** to allow this device to broadcast its SSID. Therefore, the hosts within its wireless coverage could find the wireless signals.

Network Type: Select the network type of the wireless network.

Guest Network: The hosts in a guest network cannot communicate with hosts in other wireless networks.

Office Network: Functions as a normal wireless network.

Security Mode: Select the security mode of wireless network. If all the hosts are allowed to access the wireless network without password, please select **None**. For the safety of wireless network, you are suggested to encrypt your wireless network. This device provides two security modes: **WPA/WPA2** (Wi-Fi Protected Access) and **WPA-PSK/WPA2-PSK** (WPA Pre-Shared Key). **WPA-PSK/WPA2-PSK** is recommended. Settings vary in different security modes as the details is in the following introduction.

AP Isolation: Select this checkbox to enable the AP Isolation feature that allows you to confine and restrict all wireless devices on your network from interacting with each other, but still able to access the Internet. This function will be disabled if WDS is enabled.

Enable Wireless Network: Check the box to enable this wireless network, allowing the hosts connected to the wireless network to communicate with each other.

Security Mode

Following is the detailed introduction of security mode: **WPA/WPA2** and **WPA-PSK/WPA2-PSK**.

- **WPA-PSK/WPA2-PSK**

Based on pre-shared key. It is characterized by higher safety and simple settings, which suits for common households and small business. WPA-PSK has two versions: WPA-PSK and WPA2-PSK.

The screenshot shows a configuration window for wireless security. It includes the following fields and options:

- Security Mode:** A dropdown menu set to "WPA-PSK / WPA2-PSK" with a help icon (question mark) to its right.
- Authentication Type:** A dropdown menu set to "Auto".
- Encryption:** A dropdown menu set to "AES".
- PSK Password:** A text input field containing a masked password (represented by dots) and a "Show" checkbox to its right.
- Group Key Update Period:** A text input field set to "0" with the text "Seconds, 0 means no update." to its right.

Figure 4-3 Security Mode WPA-PSK/WPA2-PSK

Authentication Type:

- **Auto:** Select WPA or WPA2 automatically based on the wireless station's capability and request.
- **WPA-PSK:** Pre-shared key of WPA.
- **WPA2-PSK:** Pre-shared key of WPA2.

Encryption: Select the encryption type, including **Auto**, **TKIP**, and **AES**. The default setting is Auto, which can select TKIP (Temporal Key Integrity Protocol) or AES (Advanced Encryption Standard) automatically based on the wireless station's capability and request. AES is more secure than TKIP and TKIP is not supported in 802.11n mode. It is recommended to select AES as the encryption type.

PSK Password: Configure the PSK password with ASCII or Hexadecimal characters. For ASCII, the length should be between 8 and 63 characters with combination of numbers, letters (case-sensitive) and common punctuations. For Hexadecimal, the length should be 64 characters (case-insensitive, 0-9, a-f, A-F).

Group Key Update Period: Specify the group key update period in seconds. The value can be either 0 or 30-8640000 seconds.

- **WPA/WPA2**

Based on Radius Server, WPA can assign different password for different users and it is much safer than WPA-PSK. However, its maintenance costs much which is only suitable for enterprise users. At present, WPA has two versions: WPA and WPA2.

The screenshot shows a configuration panel for WPA/WPA2 security mode. It contains the following fields and values:

- Authentication Type: Auto
- Encryption: Auto
- Radius Server: 0.0.0.0
- Radius Server Port: 0
- Radius Password: (empty) with a "Show" checkbox to the right.
- Group Key Update Period: 0

Below the Group Key Update Period field, there is a note: "Seconds, 0 means no update."

Figure 4-4 Security Mode WPA/WPA2

Authentication Type: Select one of the following versions:

- **Auto:** Select WPA-PSK or WPA2-PSK automatically based on the wireless station's capability and request.
- **WPA:** Wi-Fi Protected Access.
- **WPA2:** Version 2 of WPA.

Encryption: Select the encryption type, including **Auto**, **TKIP**, and **AES**. The default setting is Auto, which can select TKIP (Temporal Key Integrity Protocol) or AES (Advanced Encryption Standard) automatically based on the wireless station's capability and request. AES is more secure than TKIP and TKIP is not supported in 802.11n mode. It is recommended to select AES as the encryption type.

RADIUS Server/Port: Enter the IP address/port of the RADIUS server.

RADIUS Password: Enter the shared secret of RADIUS server to access the RADIUS server.

Group Key Update period: Specify the group key update period in seconds. The value can be either 0 or 30-8640000 seconds.

NOTE:

Encryption type TKIP is not supported in 802.11n mode. If TKIP is applied in 802.11n mode, the clients may not be able to access the wireless network of the CAP. If TKIP is applied in 11b/g/n mode, the device may work at a low transmission rate.

4.2 WDS Settings

WDS (Wireless Distribution System) is a communication system among multiple wireless local area networks established between APs through wireless connection. In this

system, only data frames with four address fields can be transparently forwarded at the link layer. In a WDS network, it is necessary that the root AP supports forwarding of data frames four address fields. If not, only data frames with the ARP/IP/PPPOE protocol can be forwarded among APs.

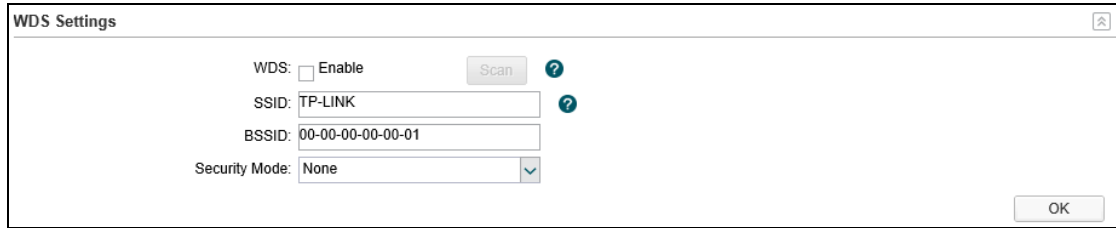
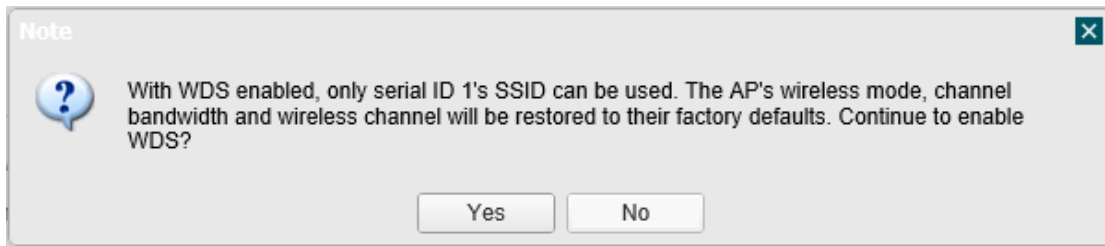

Figure 4-5 WDS Settings

Check the box and click **OK**. The following figure will be shown. Click **Yes** to enable the WDS feature.



There are two ways to select the root AP. Scan or manually enter the parameters.

Scan

Click the **Scan** button, the AP list will be shown as below. Select the desired root AP to bridge in the AP list.

ID	BSSID	SSID	Chanr	Security Mode	Signal Stren	Select
1	EC-08-6B-9F-BD-2B	TP-LINK_BD2B	1	WPA-PSK/WPA2-PSK	[Signal Strength Bar]	[Green Checkmark]
2	EA-08-6B-D4-E3-AA	TP-LINK_E3A8_2	1	WPA2-PSK	[Signal Strength Bar]	[Green Checkmark]
3	02-CA-0A-09-72-25	shiny	3	None	[Signal Strength Bar]	[Green Checkmark]
4	00-0A-EB-13-7A-FF	Smart Home	1	WPA-PSK/WPA2-PSK	[Signal Strength Bar]	[Green Checkmark]
5	18-A6-F7-2D-CA-76	EAP_TEST	1	WPA2-PSK	[Signal Strength Bar]	[Green Checkmark]
6	00-24-65-35-48-22	Home	4	None	[Signal Strength Bar]	[Green Checkmark]
7	F6-F2-6D-2F-A4-D4	onhub	6	WPA2-PSK	[Signal Strength Bar]	[Green Checkmark]
8	02-24-65-35-48-22	TP-Link	4	None	[Signal Strength Bar]	[Green Checkmark]
9	F4-F2-6D-B6-AC-5E	TP-LINK_AC5E	6	WPA-PSK/WPA2-PSK	[Signal Strength Bar]	[Green Checkmark]
10	00-0A-EB-13-12-27	TP-Link 131227	6	None	[Signal Strength Bar]	[Green Checkmark]

Figure 4-6 AP List

After selecting the desired root AP, the WDS settings page will be shown as below. If the root AP is encrypted, you should enter the PSK password manually. Click **OK** to finish the settings.

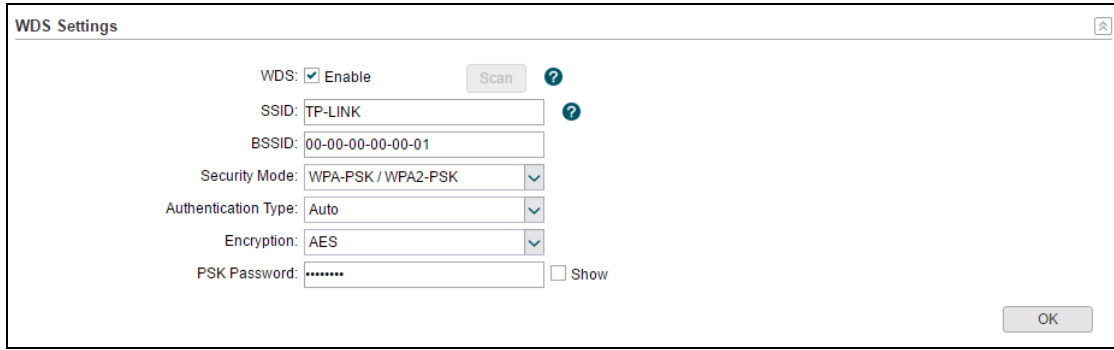

Figure 4-7 WDS Settings

Manually

You should manually enter the parameters of the root AP. Click **OK** to finish the settings.

-
- WDS:** Check the box to enable WDS feature.
-
- SSID:** The SSID of the AP your device is going to connect to as a client.
-
- BSSID:** The BSSID of the AP your device is going to connect to as a client.
-
- Security Mode:** This option should be chosen according to the AP's security configuration. It is recommended that the security type is the same as your AP's security type.
- Select the encryption type, including **None** and **WPA-PSK/WPA2-PSK**. The default setting is **None**. Please refer to **Security Mode** for details.
-

4.3 Advanced Settings

You can configure the advanced settings in this section. Improper configuration would degrade the CAP's wireless performance. With no special requirement, it is recommended to keep the default settings.

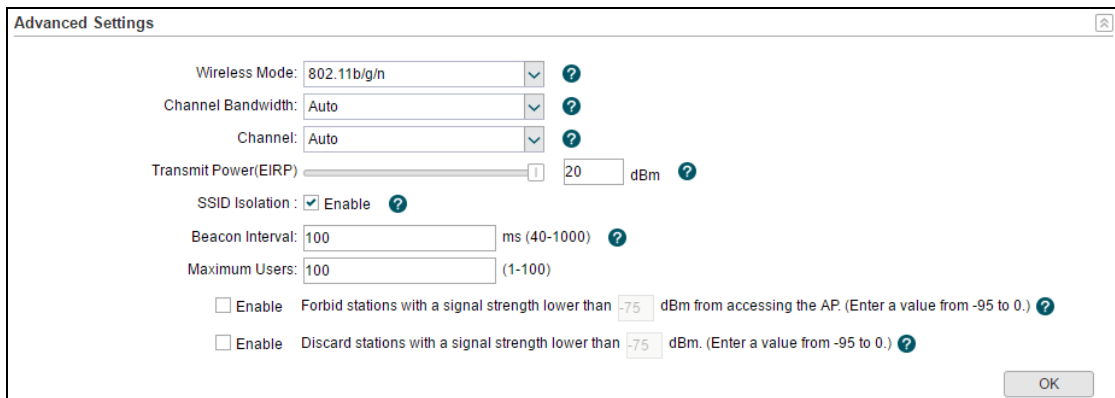

Figure 4-8 Advanced Settings

-
- Wireless Mode:** Select the protocol standard for the wireless network.
-

	It is recommended to select 802.11b/g/n, in which way clients supporting any one of these modes can access your wireless network.
Channel Bandwidth:	<p>Select the channel bandwidth of this device including 20MHz and 40MHz.</p> <p>The default setting is Auto, which will select the proper bandwidth automatically according to the network need.</p> <p>According to IEEE 802.11n standard, using a higher bandwidth can increase wireless throughput. However, users may choose lower bandwidth due to the following reasons:</p> <ol style="list-style-type: none"> 1. To increase the available number of channels within the limited total bandwidth. 2. To avoid interference from overlapping channels occupied by other devices in the environment. 3. Lower bandwidth can concentrate higher transmit power, increasing stability of wireless links over long distances.
Channel:	This field determines which operating frequency will be used. The default channel is set to Auto , so the AP will choose the best channel automatically. It is not necessary to change the wireless channel unless you notice interference problems with another nearby access point.
Transmit Power:	You can use the slider or manually enter the transmit power value. The maximum transmit power may vary among different countries or regions.
SSID Isolation:	With this option enabled, the hosts connected to different wireless networks cannot communicate with each other.
Beacon Interval:	<p>Beacons are transmitted periodically by the device to announce the presence of a wireless network for the clients.</p> <p>Enter a time interval between 40 and 1000 in milliseconds to determine the duration between beacon packets that are transmitted periodically by the device to synchronize the wireless network. The default is 100 milliseconds.</p>
Maximum Users:	Specify the maximum users that allowed to connect to the CAP.
Forbid stations with a signal strength lower than () dBm from accessing the AP:	<p>Enable or disable the access rules.</p> <p>Set the minimum signal strength for a new client to be allowed to access the network. Values from -95 to 0 dBm are valid. The default value is -75 dBm. It is recommended the maximum number is less than -40 dBm. When clients attempt to connect to the AP with lower signal strength than the threshold value (for example due to obstacles or long distances), they will be denied access to the AP.</p>

Discard stations with a signal strength lower than () dBm:	Enable or disable the discard rules. Set the minimum signal strength in which the AP will discard a connected client. Values from -95 to 0 dBm are valid. The default value is -75dBm. It is recommended the maximum number is less than -40 dBm. When the signal strength of the connected client is lower than the threshold value (for example due to obstacles or long distances), the client will be discarded by the AP.
--	---

Chapter 5 Network

On *Network* page, you can configure the wireless MAC filtering rule and set the VLANs.

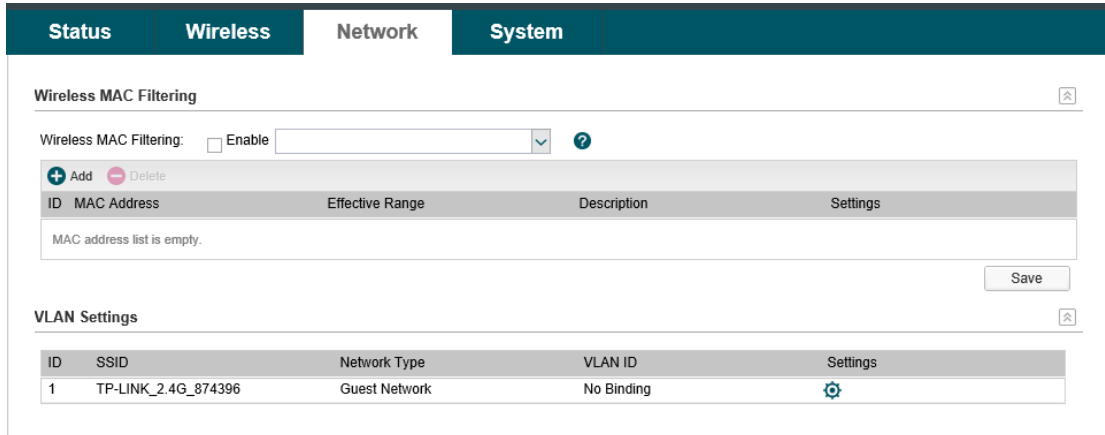
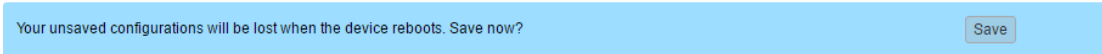

Figure 5-1 Network Page

If you have made any change of the parameters, please click **OK** to make the configuration take effect. There will be a blue bar at the top of the page to remind you to save the configuration. Click **Save** when you finish all settings, otherwise all the settings will be recovered to last saved settings at reboot or power off.



5.1 Wireless MAC Filtering

Wireless MAC Filtering feature uses MAC addresses to determine whether one host can access the wireless network or not. Thereby it can effectively control the user access in the wireless network.

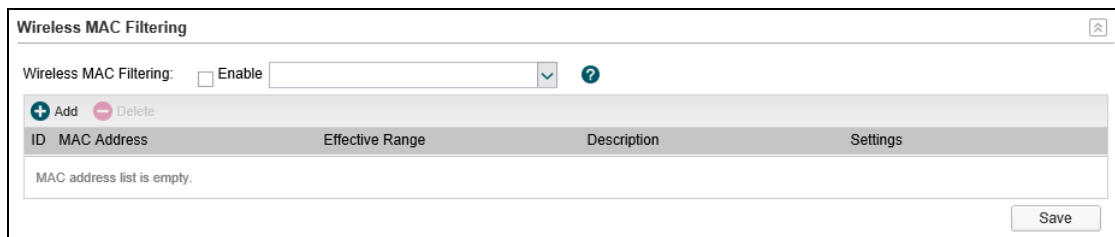
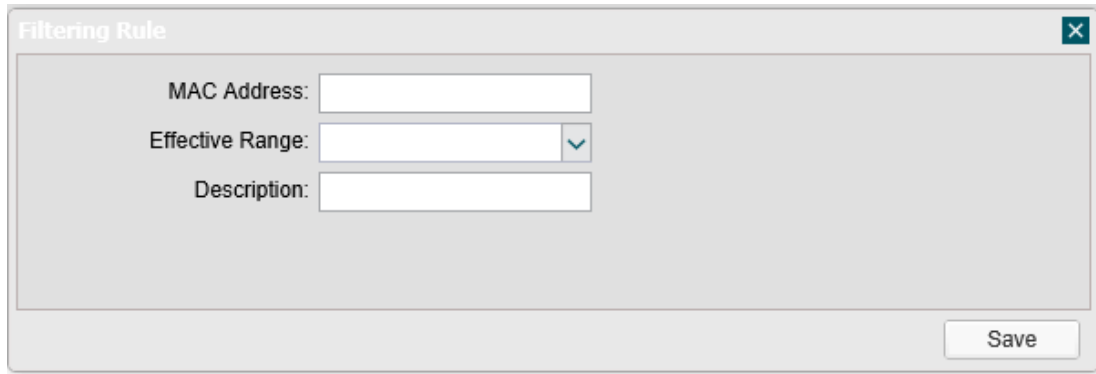

Figure 5-2 Wireless MAC Filtering

Wireless MAC Filtering: Check the box and select one or more wireless networks to enable the wireless MAC filtering on the selected wireless network(s). With MAC filtering enabled, only MAC addresses listed in the rule list can be connected to the corresponding wireless network.

Click **Add** to create a wireless MAC filtering entry. The following page will be shown.



The 'Filtering Rule' dialog box contains three input fields: 'MAC Address' (a text box), 'Effective Range' (a dropdown menu), and 'Description' (a text box). A 'Save' button is located at the bottom right of the dialog.

Figure 5-3 Filtering Rule

- MAC Address:** Enter the MAC address of the client.

- Effective Range:** Select the wireless network that allows the client to access.

- Description:** Specify a description for the entry to make it easier to search for and manage.

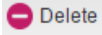
Click  button to modify the corresponding entry and click  button to delete the selected entry.

5.2 VLAN Settings

In this section, all the wireless network will be listed here.

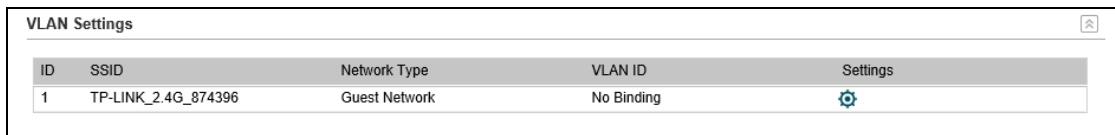



ID	SSID	Network Type	VLAN ID	Settings
1	TP-LINK_2.4G_874396	Guest Network	No Binding	

Figure 5-4 VLAN List

The CAP can add different VLAN tag to the clients which connect to the corresponding wireless network. The clients with different VLAN ID cannot directly communicate with each other. Click  button to specify the VLAN ID for the corresponding network.

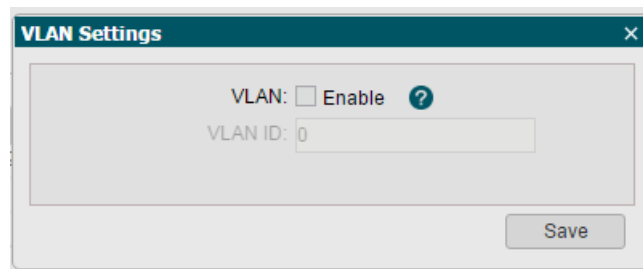

The 'VLAN Settings' dialog box features a 'VLAN' checkbox with the label 'Enable' and a help icon. Below it is a 'VLAN ID' text box containing the value '0'. A 'Save' button is positioned at the bottom right.

Figure 5-5 VLAN Settings

- VLAN:** Check the box to enable the VLAN feature.

- VLAN ID:** Specify a VLAN ID for the wireless network.

Chapter 6 System

System page is mainly used to configure some basic information like AP management, user account, system log, time setting, and realize functions including reboot, reset, backup, restore, firmware upgrade and ping watch dog.

The screenshot displays the 'System' configuration page with a dark teal header containing tabs for 'Status', 'Wireless', 'Network', and 'System'. The page is divided into several sections:

- AP Management:** Includes fields for IP Address (192.168.0.31), Mask (255.255.255.0), Default Gateway (192.168.0.1), Manage VLAN (Enable checkbox, 0), WEB Service Port (80), and Web Session Timeout (60 Minutes (5-60)).
- Account:** Includes fields for Current Username (admin), Current Password, New Username, New Password, and Confirm the Password, each with a 'Show' checkbox.
- System Log:** Includes 'Check Log' (Open), 'Download Log' (Download), 'Send To Server' (Enable checkbox), and 'Server Address' (0.0.0.0).
- Time Setting:** Includes 'Time Zone' (UTC+08:00 Beijing, Urumqi, Hong Kor), 'Date' (2014/01/02), 'Time' (00:15:45), and 'NTP Server I/II' fields.
- Configuration Management:** Includes 'Backup' (Backup), 'Restore' (Browse... Upload), 'Factory Restore' (Reset), and 'Reboot' (Reboot) buttons.
- Firmware Upgrade:** Shows 'Hardware Version: CAP300-Outdoor v1.0', 'Firmware Version: 1.0.0 Build 20161025 Rel. 56622(4555)', and a 'Firmware Upgrade' field with 'Browse...' and 'Upload' buttons.
- Ping Watch Dog:** Includes 'Ping Watch Dog' (Enable checkbox), 'Destination IP Address' (0.0.0.0), 'Ping Interval' (300 Seconds (10-300)), 'Start-up Delay' (300 Seconds (60-300)), and 'lost Packets Count' (3 (1-65535)).

Each section concludes with an 'OK' button.

Figure 6-1 System Page

If you have made any change of the parameters, please click **OK** to make the configuration take effect. There will be a blue bar at the top of the page to remind you to save the configuration. Click **Save** when you finish all settings, otherwise all the settings will be recovered to last saved settings at reboot or power off.

6.1 AP Management

You can change the IP address, mask, default gateway, web service port and web session timeout of the CAP and enable the manage VLAN.

The screenshot shows the 'AP Management' configuration interface. It includes the following fields and values:

- IP Address: 192.168.0.254
- Mask: 255.255.255.0
- Default Gateway: 192.168.0.1
- Manage VLAN: Enable 0
- WEB Service Port: 80
- Web Session Timeout: 60 Minutes (5-60)

An 'OK' button is present at the bottom right of the configuration area.

Figure 6-2 AP Management Page

IP Address: Set the IP address through which the hosts in the LAN can visit the CAP. The default setting is 192.168.0.254. You can change the IP according to the network need.

Mask: Set the mask of CAP. The default setting is 255.255.255.0. You can change it according to the network need.

Default Gateway: Set the default gateway of CAP. The default setting is 255.255.255.0. You can change it according to the network need.

Manage VLAN: Check the box to enable the manage VLAN. Specify the Manage VLAN ID. The valid values are from 1 to 4094.

Manage VLAN provides a safer way for you to manage the CAPs. With it enabled, only the hosts in the manage VLAN can log in to the CAP's webpage. Since most hosts cannot process VLAN TAGs, you should connect the management host to the network via a switch. Configure VLAN settings for the switches on the network to ensure the communication between the host and the CAP in the manage VLAN.

WEB Service Port: Set the Web service port for the CAP.

Web Session Timeout: Set the session timeout for the webpage. When you log in to the CAP's webpage, if there is no operation during the set time, the webpage will be logged out automatically.

6.2 Account

You can change the username and password to protect your device from unauthorized login.

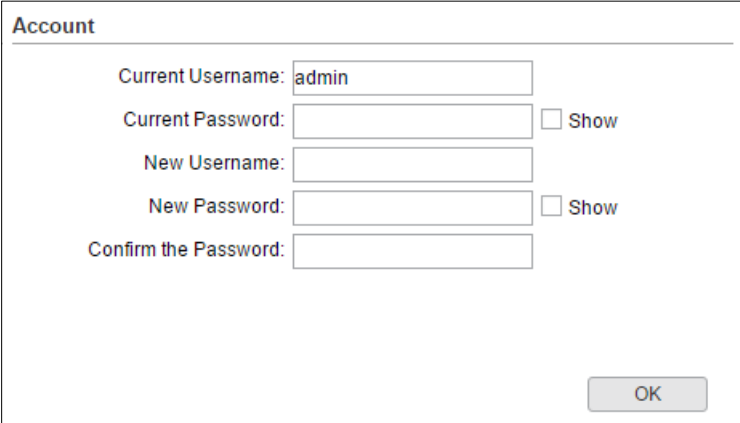

The screenshot shows a web form titled "Account". It has the following fields and controls:

- Current Username:** A text input field containing the text "admin".
- Current Password:** A text input field with a "Show" checkbox to its right.
- New Username:** A text input field.
- New Password:** A text input field with a "Show" checkbox to its right.
- Confirm the Password:** A text input field.
- OK:** A button located at the bottom right of the form.

Figure 6-3 Account Page

Current User Name/Password: Enter the current user name and password of the admin account to get the permission of modification.

New User Name/Password: Enter a new user name and password for the admin account. Both values are case-sensitive, up to 64 characters and with no space.

Confirm the Password: Enter the new password again.

6.3 System Log

Check the system log in this section.

The screenshot shows a dialog box titled "System Log". It contains the following elements:

- Check Log:** A button labeled "Open".
- Download Log:** A button labeled "Download".
- Send To Server:** A checkbox labeled "Enable", which is currently unchecked.
- Server Address:** A text input field containing "0.0.0.0".
- OK:** A button at the bottom right of the dialog.

Figure 6-4 System Log

-
- Check Log:** Click **Open** to check the system log.
-
- Download Log:** Click **Download** to download the system log.
-
- Send To Server/ Server Address:** Check the box to enable the function. If you want to check the system log in a specified host, please install a system log server and enter the server IP in this field. Click **OK**, then the AP will send the system log to the specified IP address.
-

6.4 Time Setting

System time represents the device system's notion of the passing of time. System time is the standard time for Scheduler and other time-based functions. You can manually set the system time, configure the system to acquire its time settings from a preconfigured NTP server.

The screenshot shows a dialog box titled "Time Setting". It contains the following elements:

- Time Zone:** A dropdown menu showing "(UTC+08:00) Beijing, Urumqi, Hong Kor".
- Date:** A text input field showing "2014/01/01" with a calendar icon to its right.
- Time:** A dropdown menu showing "01:46:48".
- NTP Server I:** An empty text input field.
- NTP Server II:** An empty text input field.
- OK:** A button at the bottom right of the dialog.

Figure 6-5 Time Settings

-
- Time zone:** Select your local time zone from the drop-down list.
-
- Date:** Set the current date, in format YYYY/MM/DD. For example, for November 25, 2014, enter 2014/11/25 in the field.
-

Time: Specify the device's time. Select the number from the drop-down list in time format HH/MM/SS.

NTP Server I/NTP Server II: Please input the primary NTP sever address and an alternative NTP server address.

6.5 Configuration Management

In this section, you can backup, restore, reset or reboot your CAP.

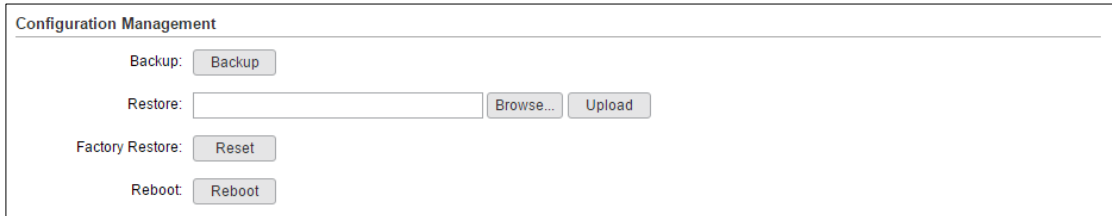

Configuration Management

Backup:

Restore:

Factory Restore:

Reboot:

Figure 6-6 Configuration Management

Backup: Click **Backup** to save a copy of your current settings. Please save your copy in a secure file location. It is recommended to back up the settings before you change the configurations and upgrade the firmware.

Restore: Click Browse to locate and select the backup file, then click Restore to import the file to recover the configurations.

Factory Restore: Click **Reset** to restore your device to its factory default settings.

Reboot: Click **Reboot** to reboot your device. Do NOT power off your device while it is rebooting.

6.6 Firmware Upgrade

Please log in <http://www.tp-link.com/> to download the latest system file. Click **Browse** to locate and select the firmware file. Click **Upload** to upload the file to upgrade.

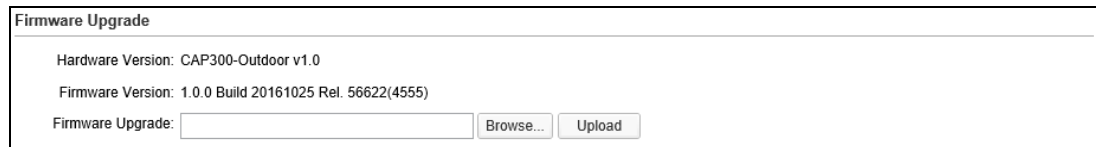

Firmware Upgrade

Hardware Version: CAP300-Outdoor v1.0

Firmware Version: 1.0.0 Build 20161025 Rel. 56622(4555)

Firmware Upgrade:

Figure 6-7 Firmware Upgrade

After the firmware is uploaded, the page below will be shown. If you want to save the current settings, please click **Save Configuration**. If you want to restore the device to factory defaults please click **Restore**.

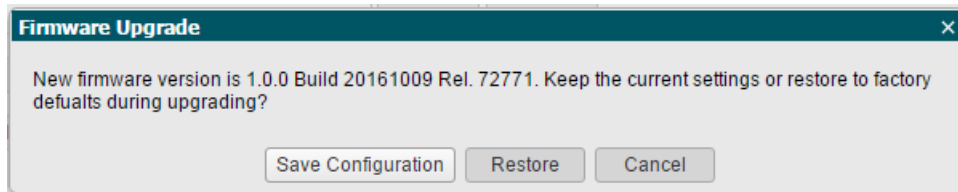

Figure 6-8 Firmware Upgrade

Hardware Version:	Display the current hardware version.
Firmware Version:	Display the current Firmware version.
Firmware Upgrade:	Click Browse to locate and select the firmware file. Click Upload to upload the file to upgrade. Do NOT power off your device while it is upgrading.

6.7 Ping Watch Dog

Ping Watch Dog sets the device to continuously ping a user-defined IP address (it can be the Internet gateway, for example) to check the network connectivity. If there is a connection failure then the device will automatically reboot.

Ping Watch Dog is dedicated to continuously monitoring the connectivity to a specific host using the Ping tool. The Ping tool sends ICMP echo request packets to the target host and listens for ICMP echo response. If the defined number of replies is not received, the tool reboots the device.

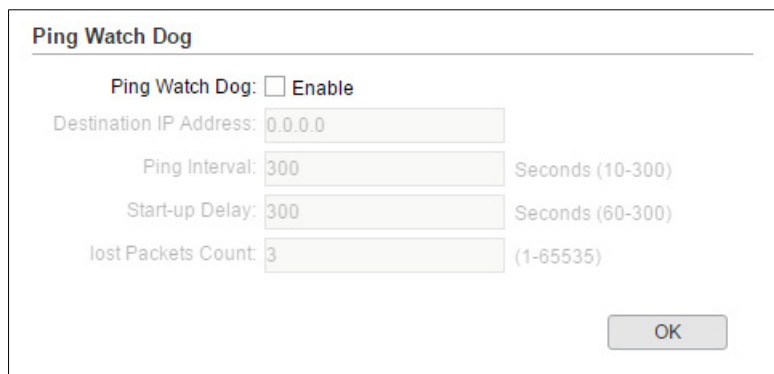

Figure 6-9 Ping Watch Dog

Ping Watch Dog:	Check the box to enable the feature.
Destination IP Address:	Specify the IP address of the target host to which the Ping Watch Dog Utility will send ping packets.
Ping Interval:	Enter the time interval (in seconds) between two successive ping packets. The default value is 300 seconds.

Start-up Delay: Enter the initial time delay (in seconds) from device startup to the first ICMP echo requests sent by Ping Watch Dog. The default value is 300 seconds.

The Startup Delay value should be at least 60 seconds as the device's initialization takes a considerable amount of time.

Lost Packets Count: Enter the fail count of ICMP echo request. If the device sends the specified count of ICMP echo requests to the host and none of the corresponding ICMP echo response packets is received, Ping Watch Dog will reboot the device. The default value is 3.
