

1

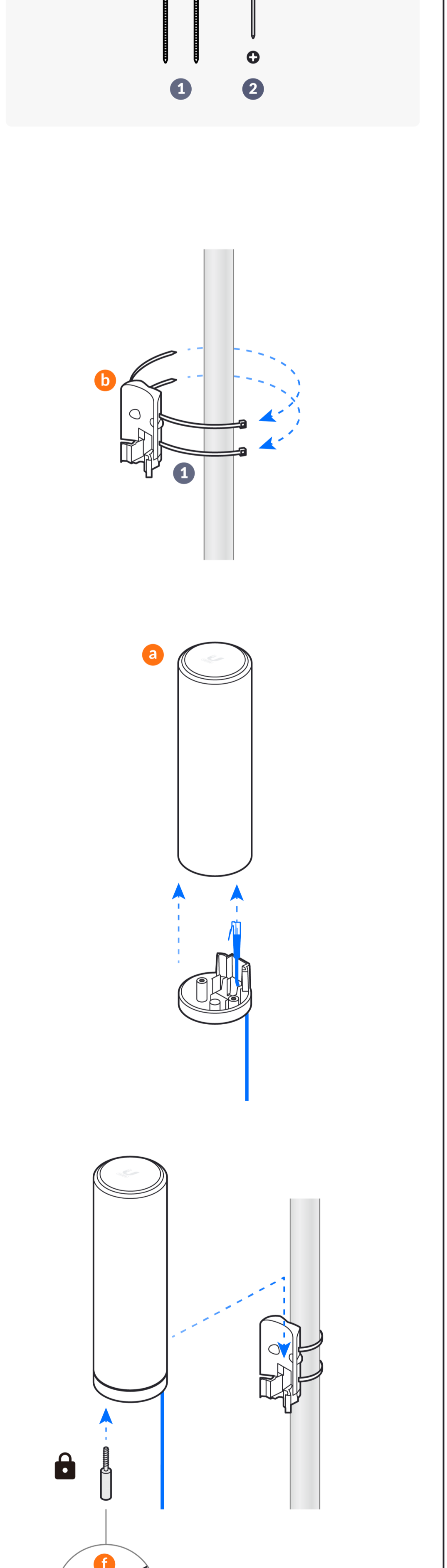

2

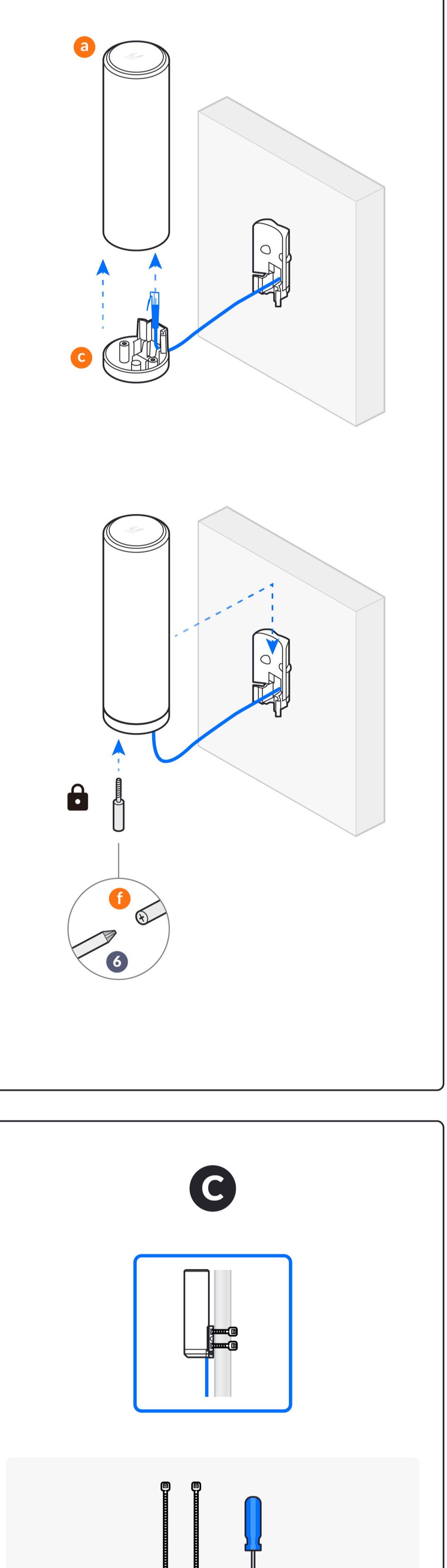
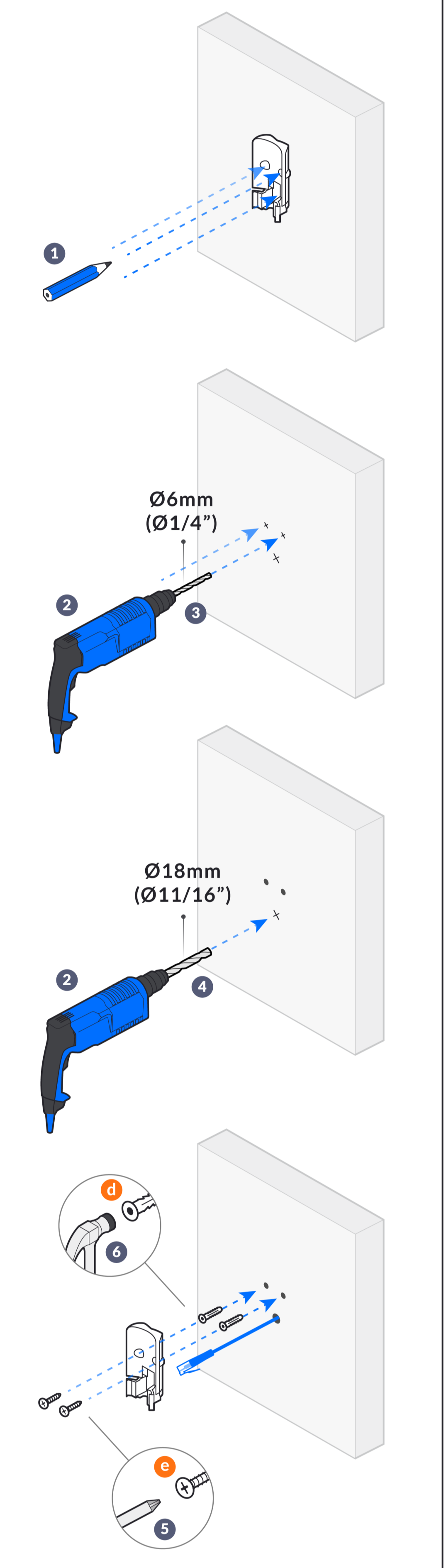
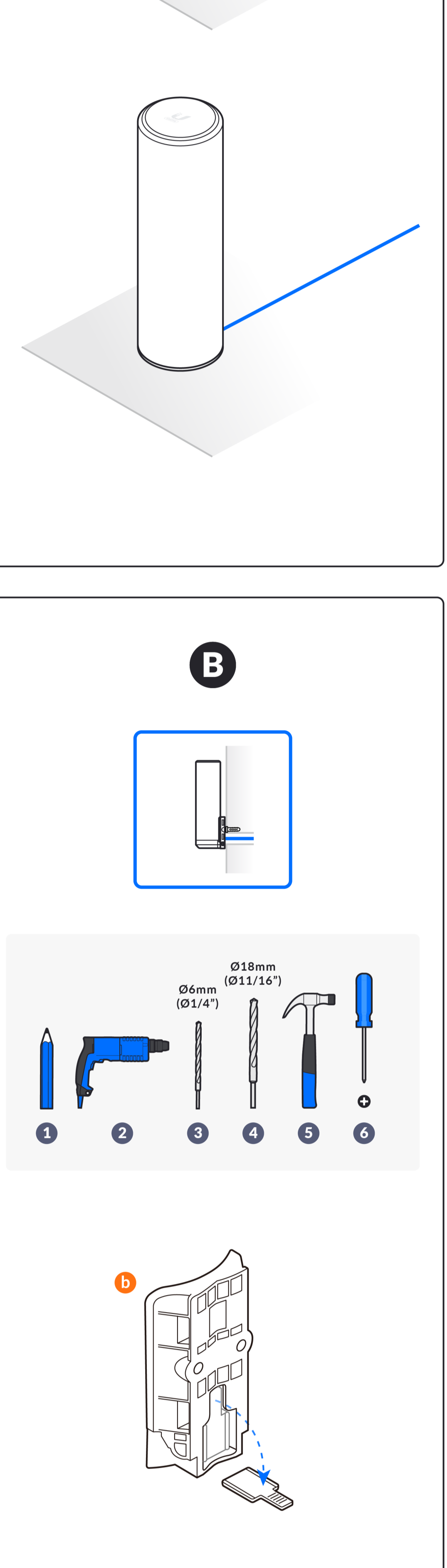

3

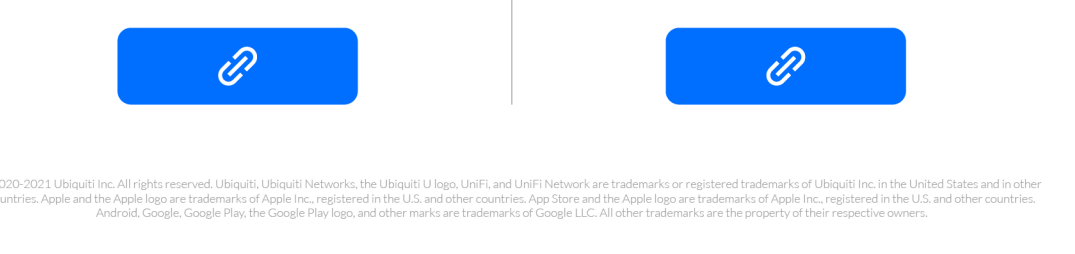
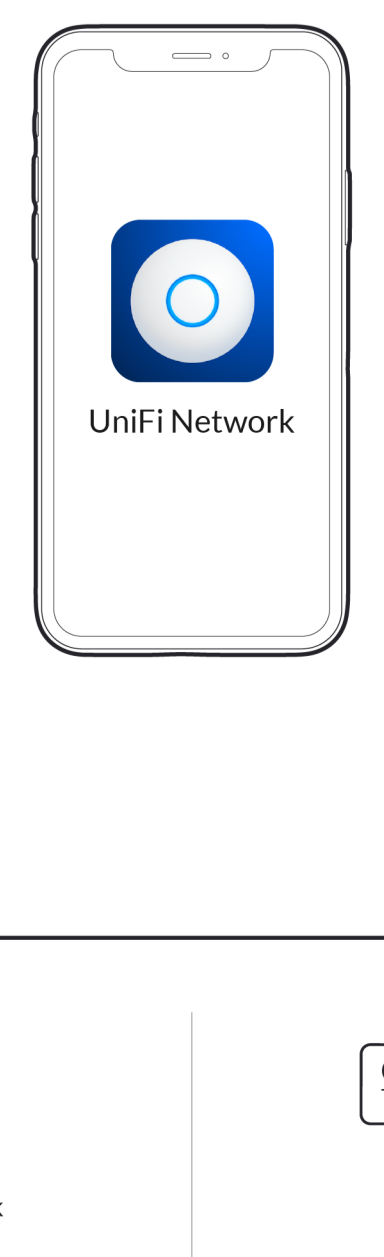
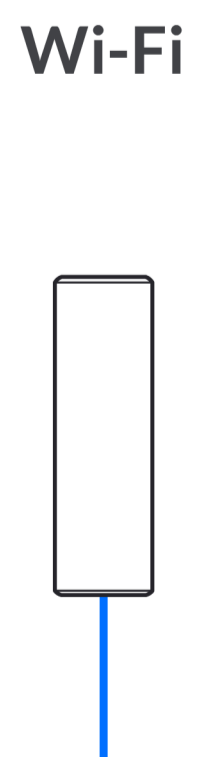

©2020 Ubiquiti, Inc. All rights reserved. UniFi and UniFi Network are trademarks of Ubiquiti, Inc. UniFi and UniFi Network are trademarks or registered trademarks of Ubiquiti, Inc. UniFi and UniFi Network are trademarks or registered trademarks of Apple Inc., registered in the U.S. and other countries. App Store and the Apple logo are trademarks of Apple Inc., registered in the U.S. and other countries. Microsoft, Google, Google Play, the Google Play logo and the names and logos of Google LLC, its other trademarks are the property of Google LLC. All other trademarks are the property of their respective owners.